

Dell PowerVault Tape Systems

# LTO Media Handbook



# Notes, Cautions, and Warnings



**NOTE:** A NOTE indicates important information that helps you make better use of your computer.



**CAUTION:** A CAUTION indicates potential damage to hardware or loss of data if instructions are not followed.



**WARNING:** A WARNING indicates a potential for property damage, personal injury, or death.

---

**Information in this publication is subject to change without notice.**

**© 2005–2013 Dell Inc. All rights reserved.**

Reproduction of these materials in any manner whatsoever without the written permission of Dell Inc. is strictly forbidden.

Trademarks used in this text: Dell™, the DELL logo, PowerEdge™, and PowerVault™ are trademarks of Dell Inc.

Other trademarks and trade names may be used in this publication to refer to either the entities claiming the marks and names or their products. Dell Inc. disclaims any proprietary interest in trademarks and trade names other than its own.

# Contents

<b>Drives and Media</b> . . . . .	<b>5</b>
PowerVault LTO-1 Tape Drives . . . . .	5
PowerVault LTO-2 Tape Drives . . . . .	7
PowerVault LTO-3 Tape Drives . . . . .	8
PowerVault LTO-4 Tape Drives . . . . .	9
PowerVault LTO-5 and LTO-6 Tape Drives . . . . .	10
Media Types for PowerVault LTO Tape Drives . . . . .	11
<b>Media Color Schemes</b> . . . . .	<b>13</b>
<b>Invalid Media Symptoms</b> . . . . .	<b>14</b>
<b>Cartridge Memory</b> . . . . .	<b>14</b>
<b>Migrating LTO Media</b> . . . . .	<b>15</b>
<b>WORM Media</b> . . . . .	<b>15</b>
<b>Cleaning Media</b> . . . . .	<b>15</b>
Label Designations on LTO Cleaning Media . . . . .	15
Cleaning Media Usage and Drive Cleaning Lights . . . . .	16
Characteristics of Expired LTO Cleaning Tape . . . . .	18
<b>Stuck Tapes</b> . . . . .	<b>21</b>
<b>Erasing a Pre-Written LTO Tape</b> . . . . .	<b>23</b>
<b>Media Handling</b> . . . . .	<b>24</b>
Media Description . . . . .	24
Perform a Thorough Inspection . . . . .	25
Handle the Cartridge Carefully . . . . .	25

Ensure Proper Packaging While Shipping Tapes. . . . . 27  
Cartridge Storage Conditions . . . . . 28  
Cartridge Life . . . . . 28  
Media Do's and Don'ts . . . . . 29



This document describes media compatibility, handling, and usage for all Dell PowerVault Linear Tape Open (LTO) drives.

## Drives and Media

Table 1 through Table 5 list the basic characteristics of Dell PowerVault LTO tape drives.

### PowerVault LTO-1 Tape Drives

**Table 1. LTO-1 Drive Types and Basic Characteristics**





	PowerVault 110T LTO	PowerVault 110T LTO-1	PowerVault 110T LTO-1
			
<b>Capacity Native /Compressed</b>	100 GB/200 GB	100 GB/200 GB	100 GB/200 GB
<b>Native Speed</b>	15 MB/s	15 MB/s	15 MB/s
<b>Primary Media</b>	Ultrium-1	Ultrium-1	Ultrium-1

**Table 1. LTO-1 Drive Types and Basic Characteristics**

	<b>PowerVault 110T LTO</b>	<b>PowerVault 110T LTO-1</b>	<b>PowerVault 110T LTO-1</b>
<b>Physical Device Description</b>	<ul style="list-style-type: none"> <li>• Single air intake at the bottom of the drive</li> <li>• Eject button at top right corner</li> <li>• Status lights (vertical)               <ul style="list-style-type: none"> <li>– Power</li> <li>– Activity</li> <li>– Error</li> <li>– Status</li> </ul> </li> </ul>	<ul style="list-style-type: none"> <li>• Ultrium-1 label on drive bezel</li> <li>• Split air intakes on both the bottom corners</li> <li>• Flush mount eject button</li> <li>• Status lights (vertical)               <ul style="list-style-type: none"> <li>– Ready</li> <li>– Drive error</li> <li>– Tape error</li> <li>– Use cleaning cartridge</li> </ul> </li> </ul>	Seven segment display <b>NOTE:</b> PowerVault 110T LTO-1 is only sold on 132T drive sled.
<b>Supported Systems</b>	<ul style="list-style-type: none"> <li>• PowerVault 110T LTO (table top and internal standalone)</li> <li>• PowerVault 122T</li> <li>• PowerVault 136T</li> <li>• PowerVault 114T</li> </ul>	PowerVault 110T LTO-1 (table top and internal standalone)	PowerVault 132T







## PowerVault LTO-2 Tape Drives

**Table 2. LTO-2 Drive Types and Basic Characteristics**

	<b>PowerVault 110T LTO2</b>	<b>PowerVault 110T LTO-2-L (Certance)</b>	<b>PowerVault 110T LTO-2-L (Tandberg)</b>
			
			
<b>Capacity (Native/Compressed)</b>	200 GB/400 GB	200 GB/400 GB	200 GB/400 GB
<b>Native Speed</b>	35 MB/s	24 MB/s	24 MB/s
<b>Primary Media</b>	Ultrium-2	Ultrium-2	Ultrium-2
<b>Physical Device Description</b>	<ul style="list-style-type: none"> <li>• Seven segment display</li> <li>• Full height</li> <li>• Ultrium-2 label</li> </ul>	<ul style="list-style-type: none"> <li>• Ultrium-2 label</li> <li>• Int drive has full height expander</li> <li>• LEDs (Vertical)                             <ul style="list-style-type: none"> <li>– Power</li> <li>– Activity</li> <li>– Error</li> <li>– Status</li> </ul> </li> </ul>	<ul style="list-style-type: none"> <li>• Ultrium-2 label</li> <li>• Half height</li> <li>• LEDs arranged horizontally with symbols</li> </ul>
<b>Supported Systems</b>	<ul style="list-style-type: none"> <li>• PowerVault 132T</li> <li>• PowerVault 136T</li> <li>• PowerVault 122T</li> <li>• PowerVault 110T LTO-2 table top and internal standalone</li> <li>• PowerVault 114T</li> </ul>	<ul style="list-style-type: none"> <li>• PowerVault 110T LTO-2-L (table top and internal standalone)</li> <li>• PowerVault 114T</li> <li>• PowerVault 124T</li> <li>• Supported internally on select systems</li> </ul>	<ul style="list-style-type: none"> <li>• PowerVault 110T LTO-2-L internal standalone</li> <li>• Supported internally on select systems</li> <li>• Supported externally on select systems</li> </ul>

## PowerVault LTO-3 Tape Drives





**Table 3. LTO-3 Drive Types and Basic Characteristics**

	PowerVault 110T LTO 3	PowerVault LTO-3-060	PowerVault LTO-3-080
			
			
<b>Capacity (Native /Compressed)</b>	400 GB/800 GB	400 GB/800 GB	400 GB/800 GB
<b>Native Speed</b>	80 MB/s	60 MB/s	80 MB/s
<b>Primary Media</b>	Ultrium-3	Ultrium-3	Ultrium-3
<b>Physical Device Description</b>	<ul style="list-style-type: none"> <li>• Seven segment display</li> <li>• Ultrium-3 label</li> <li>• Full height</li> </ul>	<ul style="list-style-type: none"> <li>• Internal/External drive</li> <li>• Half height</li> <li>• LEDs (Vertical)                             <ul style="list-style-type: none"> <li>– Power</li> <li>– Activity</li> <li>– Clean</li> <li>– Error</li> </ul> </li> </ul>	<ul style="list-style-type: none"> <li>• Seven segment display</li> <li>• Internal/External drive</li> <li>• Half height</li> </ul>
<b>Supported Systems</b>	For a list of supported tape devices, firmware, and driver versions, see the <i>Dell PowerVault Compatibility Matrix</i> at <a href="http://dell.com/pvmatrix">dell.com/pvmatrix</a> .		





## PowerVault LTO-4 Tape Drives

**Table 4. PowerVault LTO-4 Drive Types and Basic Characteristics**

	PowerVault LTO-4-120 (IBM)	PowerVault LTO-4-120 HH (IBM)
	 	 
<b>Capacity (Native/Compressed)</b>	800 GB/1600 GB	800 GB/1600 GB
<b>Native Speed</b>	120 MB/s	120 MB/s
<b>Primary Media</b>	Ultrium-4	Ultrium-4
<b>Physical Device Description</b>	<ul style="list-style-type: none"> <li>• Seven segment display</li> <li>• Ultrium-4 label</li> <li>• Full height</li> <li>• Internal/External drive</li> </ul>	<ul style="list-style-type: none"> <li>• Seven segment display</li> <li>• Ultrium-4 label</li> <li>• Half height</li> <li>• Internal/External drive</li> </ul>
<b>Supported Systems</b>	For a list of supported tape devices, firmware, and driver versions, see the <i>Dell PowerVault Compatibility Matrix</i> at <a href="http://dell.com/pvmatrix">dell.com/pvmatrix</a> .	

## PowerVault LTO-5 and LTO-6 Tape Drives

**Table 5. PowerVault LTO-5 and LTO-6 Drive Types and Basic Characteristics**

	PowerVault LTO-5-140 (IBM)	PowerVault LTO-6
		
<b>Capacity (Native/Compressed)</b>	1500 GB/3000 GB	2500GB/6250 GB
<b>Native Speed</b>	140 MB/s	160 MB/s
<b>Primary Media</b>	Ultrium-5	Ultrium-6
<b>Physical Device Description</b>	<ul style="list-style-type: none"> <li>• Seven segment display</li> <li>• Ultrium-5 label</li> <li>• Half height</li> <li>• Internal/External drive</li> </ul>	<ul style="list-style-type: none"> <li>• Seven segment display</li> <li>• Ultrium-6 label</li> <li>• Half height</li> <li>• Internal/External drive</li> </ul>
<b>Supported Systems</b>	For a list of supported tape devices, firmware, and driver versions, see the <i>Dell PowerVault Compatibility Matrix</i> at <a href="http://dell.com/pvmatrix">dell.com/pvmatrix</a> .	

## Media Types for PowerVault LTO Tape Drives

**Table 6. Supported Ultrium Media Types Per PowerVault 110 LTO Tape Drive**

	Ultrium-1 Media	Ultrium-2 Media	Ultrium-3 Media	Ultrium-4 Media	Ultrium-5 Media	Ultrium-6 Media
<b>Part No.</b>	340-7240	340-8701	341-2645	341-4640	342-1103	342-5450
<b>PowerVault 110T LTO</b>	P	×	×	×	×	×
<b>PowerVault 110T LTO-1</b>	P	×	×	×	×	×
<b>PowerVault 110T LTO-2</b>	BC-RW	P	×	×	×	×
<b>PowerVault 110T LTO-2- L (Certance)</b>	BC-RW	P	×	×	×	×
<b>PowerVault 110T LTO-2- L (Tandberg)</b>	BC-RW	P	×	×	×	×
<b>PowerVault 110T LTO 3 (IBM)</b>	BC-R	BC-RW	P	×	×	×
<b>PowerVault LTO3-060 (IBM)</b>	BC-R	BC-RW	P	×	×	×
<b>PowerVault LTO3-080 (IBM)</b>	BC-R	BC-RW	P	×	×	×
<b>PowerVault LTO4-120</b>	×	BC-R	BC-RW	P	×	×
<b>PowerVault LTO5-140</b>	×	×	BC-R	BC-RW	P	×
<b>PowerVault LTO6</b>	×	×	×	BC-R	BC-RW	P

× - Not Supported

BC-R - Backward Compatible - Read Only

BC-RW - Backward Compatible - Read/Write

P - Primary

**Table 7. Supported LTO Media Types Per PowerVault 110 LTO Tape Drive**

	LTO-3 WORM Media	LTO-4 WORM Media	LTO-5 WORM Media	LTO-6 WORM Media
<b>Part No.</b>	341-2655	341-4647	342-1105	342-5452
<b>PowerVault 110T LTO</b>	×	×	×	×
<b>PowerVault 110T LTO-1</b>	×	×	×	×
<b>PowerVault 110T LTO-2</b>	×	×	×	×
<b>PowerVault 110T LTO-2- L (Certance)</b>	×	×	×	×
<b>PowerVault 110T LTO-2- L (Tandberg)</b>	×	×	×	×
<b>PowerVault 110T LTO 3 (IBM)</b>	P	×	×	×
<b>PowerVault LTO3-060 (IBM)</b>	P	×	×	×
<b>PowerVault LTO3-080 (IBM)</b>	P	×	×	×
<b>PowerVault LTO4-120</b>	BC-RW	P	×	×
<b>PowerVault LTO5-140</b>	BC-R	BC-RW	P	×
<b>PowerVault LTO6</b>	×	BC-R	BC-RW	P

×- Not Supported  
 BC-R - Backward Compatible - Read Only  
 BC-RW - Backward Compatible - Read/Write  
 P - Primary

## Media Color Schemes

Table 8 describes the media color schemes and labels for PowerVault LTO tapes.

**Table 8. Ultrium Media Color Schemes for PowerVault LTO Tapes**

Media Type	Ultrium-1 Media	Ultrium-2 Media	Ultrium-3 Media	Ultrium-4 Media	Ultrium-5 Media	Ultrium-6 Media
Color Scheme	Black	Purple	Blue-Gray	Green	Red	Black
Label	Ultrium-1	Ultrium-2	Ultrium-3	Ultrium-4	Ultrium-5	Ultrium-6

**Table 9. LTO WORM Media Color Schemes for PowerVault LTO Tapes**

Media Type	LTO-3 WORM Media	LTO-4 WORM Media	LTO-5 WORM Media	LTO-6 WORM Media
Color Scheme	Blue-Gray on top and gray below	Green on top and gray below	Red on top and gray below	Black on top and gray below



**NOTE:** All Dell LTO cleaning media are black in color. Depending on the vintage of the cartridge, it may be marked Ultrium 1, 2, 3, or a combination of 1, 2, and 3 and so on. For more details on cleaning media, see "Cleaning Media" on page 15.



**NOTE:** PowerVault LTO tape drives are compatible with LTO Ultrium logo compliant media. However, Dell LTO Ultrium media is recommended since it has been extensively tested with PowerVault LTO tape products.



**NOTE:** WORM media that is not labeled "Dell" is always two toned with gray on the bottom and uses the respective color chosen by the tape vendor on the top.



**NOTE:** The WORM label is present on the media regardless of media vendor.

## Invalid Media Symptoms

PowerVault LTO tape drive with invalid media displays the following symptoms:

- Cleaning light turns on.
- Media light flashes or stays on.
- Tape ejects.
- Backup software reports invalid media.
- Error code 7 is displayed on drives with a seven segment display.

## Cartridge Memory

Tape drives require information about the tape cartridge being used. For LTO tape cartridges, this information is stored in a small chip within the tape and is referred to as the Cartridge Memory (CM). CM is a nonvolatile memory that responds through a passive radio frequency interface.

The CM holds the following information:

- The type of cartridge
- Important information that the drive uses to setup and calibrate
- The tape directory to enable a quick search for data sets

You experience difficulties with the cartridge if the CM is damaged or corrupted. However, the user data can still be recovered. To recover the data, set the write protect tab on the cartridge and the load the cartridge into an Ultrium drive.

The drive stores enough information on tape to be able to recognize the tape. However, the data directory is lost. Hence, the drive can only search from the beginning of tape (BOT) to end of tape (EOT) across all wraps to find the data. A **Fast Search** to the correct location is not possible.



**NOTE:** Recovery of data from a full tape could take up to 3 hours.

## Migrating LTO Media

Known issues for media migration from one manufacturer to another are fixed through the drive firmware. Use the latest available firmware for the drive, regardless of which vendor/OEM product is being used to create media. This ensures optimal performance for migrating tape between different drive vendors.



**NOTE:** LTO technology is built on an open standard. Migrating media from one drive manufacturer to another is fully supported.



**NOTE:** For information on backward read/write compatibility of the systems, see Table 6.

## WORM Media

WORM media stands for Write Once, Read Many. This means once data is written to a piece of WORM media, the data on the tape cannot be changed or overwritten. WORM media can be appended to if data is already present on the tape. The media also stores unique identifiers which allow the drive to determine whether or not the media has been tampered with.

WORM media offers a method of data retention for compliance laws such as the Sarbanes-Oxley Act of 2002. Specific WORM media barcode labels end in **LT**.

## Cleaning Media



**NOTE:** LTO drives in general do not require frequent cleaning.

### Label Designations on LTO Cleaning Media

For the last several years, LTO drives have been using **UCC** (universal cleaning cartridges) as cleaning tapes. Prior to the **universal** or **for use with all** designation of cleaning media, vendor specific cleaning media was used. This document provides information on only **universal** or **for use with all** cleaning media. If a tape is not labeled **universal** or **for use with all**, then it is recommended that you purchase a tape with that designation.



**NOTE:** LTO-1, 2, 3, 4, 5, and 6 all use the same cleaning media although it may not be labeled as such depending on the vintage of the tape.

## Cleaning Media Usage and Drive Cleaning Lights

 **NOTE:** New Dell UCC tapes are labeled—**For Use With All Ultrium 1, 2, 3, 4, 5, and 6 Drives.**

**Table 10. Characteristics For Cleaning Drives**

<b>Physical Description</b>	Black tape labeled <b>For Use With All Ultrium X</b> drives, Ultrium 2, 3, 4, 5, and 6 may or may not be written on the tape.
<b>Part Number</b>	310-5084

<b>Drive Type</b>	<b>No. of tape Media Motion hours before cleaning light illuminates</b>	<b>No. of uses before cleaning tape expires</b>	<b>How the cleaning requirement is displayed</b>
<b>Dell PowerVault 110T LTO</b>	Not Supported	15	Cleaning cartridge light
<b>Dell PowerVault 110T LTO-1</b>	500	50	Status light
<b>Dell PowerVault 110T LTO-2-L (Certance)</b>	500	50	Power light on solid green, Status light on solid amber
<b>Dell PowerVault 110T LTO-2-L (Tandberg)</b>	100	50	Cleaning LED (amber) ON
<b>Dell PowerVault 110T LTO-2 (IBM)</b>	Not Supported	50	C on seven segment display
<b>Dell PowerVault 110T LTO-3 (IBM)</b>	See Table 11	50	C on seven segment display
<b>Dell PowerVault 110T LTO-3-060 (IBM)</b>	See Table 11	50	Cleaning LED (amber) ON
<b>Dell PowerVault 110T LTO-3-080 (IBM)</b>	See Table 11	50	C on seven segment display
<b>Dell PowerVault 110T LTO-4 (IBM)</b>	See Table 11	50	C on seven segment display



<b>Drive Type</b>	<b>No. of tape Media Motion hours before cleaning light illuminates</b>	<b>No. of uses before cleaning tape expires</b>	<b>How the cleaning requirement is displayed</b>
<b>Dell PowerVault 110T LTO-4-120HH (IBM)</b>	See Table 11	50	C on seven segment display
<b>Dell PowerVault 110T LTO-5-140 (IBM)</b>	See Table 11	50	C on seven segment display
<b>Dell PowerVault 110T LTO-6</b>	See Table 11	50	C on seven segment display

**Table 11. Cleaning Interval Characteristics**

	<b>MM (xE6)</b>	<b>FFP equiv.</b>	<b>TB equiv.</b>	<b>MMH Short</b>	<b>MMH Long</b>
<b>LTO2</b>	0.7	19	4	31	63
<b>LTO3</b>	1.1	38	16	57	153
<b>LTO4</b>	1	22	19	45	173
<b>LTO5 HH</b>	0.5	8	12	24	82
<b>LTO6</b>	3.7	15	15	66	612

**Legend**

- MM (xE6)** Motion Meters
- FFP equiv.** The approximate amount of full file passes worth of data that is processed when you stream data with low space, locate commands, and standard number of rewinds.
- TB equiv.** The approximate data processed (in TB) if streaming data with low space and locate commands and standard number of rewinds. It refers to the capacity to clean.
- MMH Short** Media Motion Hours if the drive operates at the fastest speed with equivalent generation media for the entire operational period.
- MMH Long** Media Motion Hours if the drive operates at the slowest speed with equivalent generation media for the entire operational period.

The cleaning light on an LTO drive turns on for the following reasons:

- A periodic maintenance threshold has exceeded.
  - If the tape drive has processed the number of equivalent FFP, including read and writes for the generation of the drive (this can be converted to TB) before reaching the maximum MM.
  - The drive has processed the maximum MM for the generation of the drive indicated (MMxE6) before reaching the maximum amount of data that can be processed.
- A high error rate has occurred. This can happen due to the following:
  - A head clog
  - A hardware failure on the drive
  - Bad or marginal media



**NOTE:** If you perform a backup with verification, you see a cleaning request twice as frequently as you do when you perform a backup without verification. Verification doubles the number of passes the tape makes over the head.



**NOTE:** Most backup applications support Tape Alerts. If the tape drive requests cleaning, the backup software notifies you of the need to clean.

## Characteristics of Expired LTO Cleaning Tape

**Table 12. Characteristics of Expired LTO Cleaning Tape in Various Drives**

Drive Type	Cleaning with a Good Tape	Cleaning with an Expired Tape
<b>Dell PowerVault 110T LTO</b>	<ul style="list-style-type: none"> <li>• Ready light blinks green.</li> <li>• Use cleaning cartridge light turns on.</li> <li>• Ejects tape when done.</li> </ul>	<ul style="list-style-type: none"> <li>• Ready light blinks green.</li> <li>• Ejects tape out shortly after inserting.</li> </ul>
<b>Dell PowerVault 110T LTO-1</b>	<ul style="list-style-type: none"> <li>• Power light on solid green.</li> <li>• Activity light on solid green.</li> <li>• Status light on solid amber.</li> <li>• Ejects tape when complete.</li> </ul>	<ul style="list-style-type: none"> <li>• Power light on solid green.</li> <li>• Activity light on solid green.</li> <li>• Status light blinks amber.</li> <li>• Ejects tape shortly after inserting.</li> </ul>

**Table 12. Characteristics of Expired LTO Cleaning Tape in Various Drives (continued)**

Drive Type	Cleaning with a Good Tape	Cleaning with an Expired Tape
<b>Dell PowerVault 110T LTO-2</b>	<p>No seven segment display indicator.</p> <ul style="list-style-type: none"> <li>• Activity light blinks green.</li> <li>• Ejects tape shortly after.</li> </ul>	<ul style="list-style-type: none"> <li>• <b>Pre firmware 53Y3:</b> No seven segment display indicator. Activity light blinks green but ejects tape shortly after inserting.</li> <li>• <b>Firmware 53Y3 and newer:</b> <ul style="list-style-type: none"> <li>– Seven segment display shows 7</li> <li>– Activity light blinks amber</li> <li>– Ejects tape shortly after inserting. When tape is completely removed, all light indicators turn off.</li> </ul> </li> </ul>
<b>Dell PowerVault 110T LTO-2-L (Certance)</b>	<ul style="list-style-type: none"> <li>• Power light on solid green.</li> <li>• Activity light on solid green.</li> <li>• Status light on solid amber.</li> <li>• Ejects tape when complete.</li> </ul>	<ul style="list-style-type: none"> <li>• Power light on solid green.</li> <li>• Activity light on solid green.</li> <li>• Status light blinks amber.</li> <li>• Ejects tape shortly after inserting.</li> </ul>
<b>Dell PowerVault 110T LTO-2-L (Tandberg)</b>	<ul style="list-style-type: none"> <li>• Press and hold the Eject button for 6 seconds. The drive enters the service mode indicated by all LEDs flashing slowly.</li> <li>• Press Eject twice. The Activity LED flashes fast.</li> <li>• Ejects tape shortly after.</li> </ul>	<ul style="list-style-type: none"> <li>• Cleaning light turns on.</li> <li>• Activity light flashes.</li> <li>• Fault light flashes.</li> <li>• Cartridge hold in the drive</li> </ul> <p>When pressing Eject button, the cartridge is ejected and the Cleaning light stays on.</p>
<b>Dell PowerVault 110T LTO-3</b>	<p>No seven segment display indicator.</p> <ul style="list-style-type: none"> <li>• Activity light blinks green</li> <li>• Ejects tape shortly after.</li> </ul>	<ul style="list-style-type: none"> <li>• Seven segment display shows 7.</li> <li>• Activity light blinks amber.</li> <li>• Ejects tape shortly after inserting. When tape is completely removed, all light indicators turn off.</li> </ul>

**Table 12. Characteristics of Expired LTO Cleaning Tape in Various Drives (continued)**

<b>Drive Type</b>	<b>Cleaning with a Good Tape</b>	<b>Cleaning with an Expired Tape</b>
<b>Dell PowerVault LTO3-060</b>	No seven segment display indicator. <ul style="list-style-type: none"> <li>• Activity light blinks green.</li> <li>• Ejects tape shortly after.</li> </ul>	<ul style="list-style-type: none"> <li>• Cleaning light blinks amber.</li> <li>• Ejects tape shortly after inserting. When tape is completely removed, all light indicators turn off.</li> </ul>
<b>Dell PowerVault LTO3-080</b>	No seven segment display indicator. <ul style="list-style-type: none"> <li>• Activity light blinks green.</li> <li>• Ejects tape shortly after.</li> </ul>	<ul style="list-style-type: none"> <li>• Seven segment display shows 7.</li> <li>• Activity light blinks amber.</li> <li>• Ejects tape shortly after inserting. When tape is completely removed, all light indicators turn off.</li> </ul>
<b>Dell PowerVault LTO4-120</b>	No seven segment display indicator. <ul style="list-style-type: none"> <li>• Activity light blinks green.</li> <li>• Ejects tape shortly after.</li> </ul>	<ul style="list-style-type: none"> <li>• Seven segment display shows 7.</li> <li>• Activity light blinks amber.</li> <li>• Ejects tape shortly after inserting. When tape is completely removed, all light indicators turn off.</li> </ul>
<b>Dell PowerVault LTO4-120HH</b>	No seven segment display indicator. <ul style="list-style-type: none"> <li>• Activity light blinks green.</li> <li>• Ejects tape shortly after.</li> </ul>	<ul style="list-style-type: none"> <li>• Seven segment display shows 7.</li> <li>• Activity light blinks amber.</li> <li>• Ejects tape shortly after inserting. When tape is completely removed, all light indicators turn off.</li> </ul>
<b>Dell PowerVault LTO5-140</b>	No seven segment display indicator. <ul style="list-style-type: none"> <li>• Activity light blinks green.</li> <li>• Ejects tape shortly after.</li> </ul>	<ul style="list-style-type: none"> <li>• Seven segment display shows 7.</li> <li>• Activity light blinks amber.</li> <li>• Ejects tape shortly after inserting. When tape is completely removed, all light indicators turn off.</li> </ul>
<b>Dell PowerVault LTO6</b>	No seven segment display indicator. <ul style="list-style-type: none"> <li>• Activity light blinks green.</li> <li>• Ejects tape shortly after.</li> </ul>	<ul style="list-style-type: none"> <li>• Seven segment display shows 7.</li> <li>• Activity light blinks amber.</li> <li>• Ejects tape shortly after inserting. When tape is completely removed, all light indicators turn off.</li> </ul>



**NOTE:** Run Dell Online PowerEdge Diagnostics to determine media or hardware related failures.



**NOTE:** Dell Online PowerEdge Diagnostics does not support PowerVault 110T LTO tape drives. For more information, see Table 1.

## Stuck Tapes

A stuck tape can result from a dropped or damaged media. Different drives react differently when damaged media is inserted. Some may eject the tape, while others may be stuck permanently with the drive and require the drive to be returned. Most LTO drives have the capability to reset the drive in the event of a stuck tape or other non-responsive drive issues. Table 13 describes how to reset your PowerVault LTO tape drive.



**NOTE:** A drive reset may or may not help remove a stuck tape.



**NOTE:** Dell PowerEdge Diagnostics includes a **Media Eject** test that can be run to force eject a tape.

**Table 13. Resetting Your PowerVault 110T LTO Tape Drive**

Drive Type	Device Reset Procedure
<b>Dell PowerVault 110T LTO</b>	Insert a paper clip to press the <b>Reset</b> button on the front panel of the drive.
<b>Dell PowerVault 110T LTO-1</b>	<ol style="list-style-type: none"> <li>1 Press and hold the <b>Eject</b> button for more than 5 seconds.</li> <li>2 Release the <b>Eject</b> button.</li> <li>3 Press <b>Eject</b> again to eject tape.</li> </ol>
<b>Dell PowerVault 110T LTO-2-L (Certance)</b>	Press and hold the <b>Eject</b> button for more than 5 seconds. The tape should eject within 40 seconds.
<b>Dell PowerVault 110T LTO-2-L (Tandberg)</b>	<ol style="list-style-type: none"> <li>1 Press and hold the <b>Eject</b> button for 6 seconds. The drive enters Service mode and all the LEDs flash slowly.</li> <li>2 Press <b>Eject</b> twice, the Activity LED flashes fast, then double-click the <b>Eject</b> button.</li> </ol>
<b>Dell PowerVault 110T LTO-2</b>	<ol style="list-style-type: none"> <li>1 Press and hold the <b>Eject</b> button for more than 10 seconds.</li> <li>2 Release the <b>Eject</b> button.</li> <li>3 Press <b>Eject</b> again to eject tape.</li> </ol>
<b>Dell PowerVault 110T LTO-3</b>	<ol style="list-style-type: none"> <li>1 Press and hold the <b>Eject</b> button for more than 10 seconds.</li> <li>2 Release the <b>Eject</b> button.</li> <li>3 Press <b>Eject</b> again to eject tape.</li> </ol>

**Table 13. Resetting Your PowerVault 110T LTO Tape Drive (continued)**

<b>Drive Type</b>	<b>Device Reset Procedure</b>
<b>Dell PowerVault 110T LTO3-060 (IBM)</b>	<ol style="list-style-type: none"><li>1 Press and hold the Eject button for more than 10 seconds.</li><li>2 Release the Eject button.</li><li>3 Press Eject again to eject tape.</li></ol>
<b>Dell PowerVault 110T LTO3-060 (Tandberg)</b>	<ol style="list-style-type: none"><li>1 Press and hold the Eject button for six seconds. The drive enters service mode and all the LEDs flash slowly.</li><li>2 Press Eject twice. The Activity LED flashes fast.</li><li>3 Double-click the Eject button.</li></ol>
<b>Dell PowerVault 110T LTO3-080 (IBM)</b>	<ol style="list-style-type: none"><li>1 Press and hold the Eject button for more than 10 seconds.</li><li>2 Release the Eject button.</li><li>3 Press Eject again to eject tape.</li></ol>
<b>Dell PowerVault 110T LTO4-120</b>	<ol style="list-style-type: none"><li>1 Press and hold the Eject button for more than 10 seconds.</li><li>2 Release the Eject button.</li><li>3 Press Eject again to eject tape.</li></ol>
<b>Dell PowerVault 110T LTO4-120HH</b>	<ol style="list-style-type: none"><li>1 Press and hold the Eject button for more than 10 seconds.</li><li>2 Release the Eject button.</li><li>3 Press Eject again to eject tape.</li></ol>
<b>Dell PowerVault 110T LTO5-140</b>	<ol style="list-style-type: none"><li>1 Press and hold the Eject button for more than 10 seconds.</li><li>2 Release the Eject button.</li><li>3 Press Eject again to eject tape.</li></ol>
<b>Dell PowerVault 110T LTO6</b>	<ol style="list-style-type: none"><li>1 Press and hold the Eject button for more than 10 seconds.</li><li>2 Release the Eject button.</li><li>3 Press Eject again to eject tape.</li></ol>



**NOTE:** It may take up to 20 minutes for a tape cartridge to fully rewind and eject.

## Erasing a Pre-Written LTO Tape

**⚠ CAUTION:** Do not bulk erase Ultrium format cartridges. This destroys pre-recorded servo information and renders the cartridge unusable.

The erase feature in the backup software is the preferred method for erasing an LTO tape. To prevent erasing a tape, slide the write-protect switch to the right.

**✍ NOTE:** Write-protection does not prevent a cartridge from being erased by bulk-erasure or degaussing.

**Figure 1-1. Setting the Write-Protect Switch**

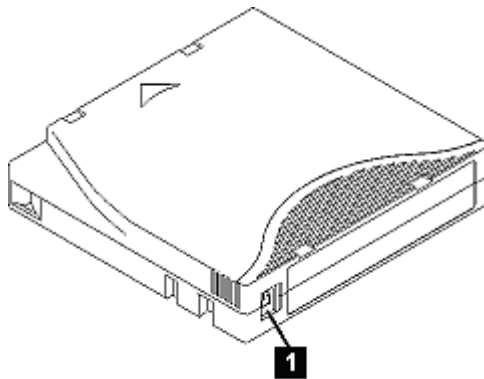

1 write-protect switch

# Media Handling

## Media Description

Figure 1-2. LTO Ultrium Data Cartridge

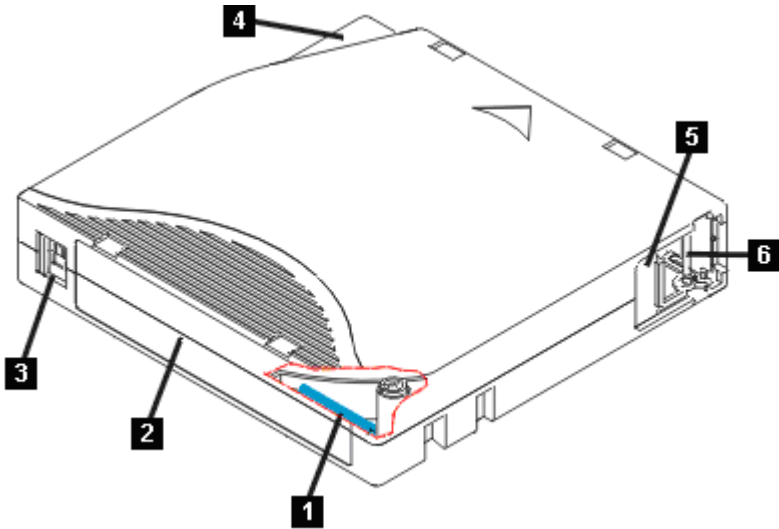

- |   |            |   |                      |   |                |
|---|------------|---|----------------------|---|----------------|
| 1 | LTO CM     | 3 | write-protect switch | 5 | cartridge door |
| 2 | label area | 4 | insertion guide      | 6 | leader pin     |

Figure 1-3. Correct Leader Pin Location

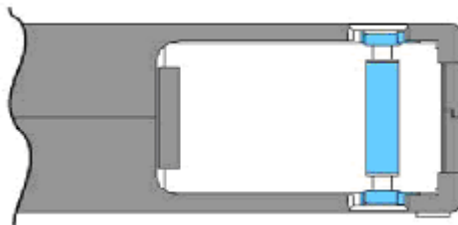



## **Perform a Thorough Inspection**

- Inspect the cartridge packaging to check for any rough handling.
- When inspecting a cartridge, open only the cartridge door. Do not open any other part of the cartridge case. The upper and lower parts of the case are held together with screws; separating them destroys the usefulness of the cartridge. While the door is open, check that the leader pin is properly seated. If the cartridge has been dropped, it is likely that the pin is dislodged inside the cartridge. It is recommended that you open the door and check if the pin is properly seated before each use. See Figure 1-4.
- Inspect the cartridge for damage before using or storing it.
- Inspect the back of the cartridge (the part that you load first into the tape load compartment) and ensure that there are no gaps in the seam of the cartridge case. If there are gaps in the seam, the leader pin may be dislodged. See Figure 1-5.
- If you suspect that the cartridge has been mishandled but it appears usable, copy any data onto a good cartridge immediately for possible data recovery. Discard the mishandled cartridge.

## **Handle the Cartridge Carefully**

- Do not drop the cartridge. If the cartridge drops, slide the cartridge door back and ensure that the leader pin is properly seated in the pin-retaining spring clips.
- Do not handle tape that is outside the cartridge. Handling the tape can damage the tape surface or edges, which may interfere with the read or write reliability. Pulling on tape that is outside the cartridge can damage the tape and the brake mechanism in the cartridge.
- Do not stack more than six cartridges.
- Do not degauss a cartridge that you intend to reuse. Degaussing renders the tape unusable.

Figure 1-4 displays a dropped tape which resulted in a dislodged leader pin. This cartridge if inserted into a drive could result in a stuck tape. Other damage could result in the leader pin falling out of the cartridge or getting dropped inside the tape housing.

**Figure 1-4. Media Inspection - Bad Tape**

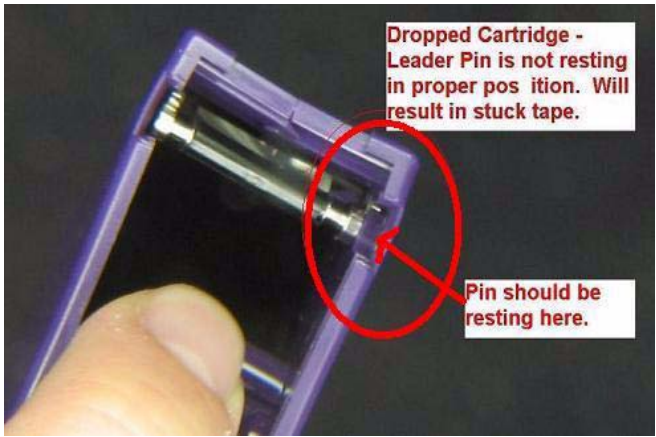



Figure 1-5 displays a tape that has been dropped and the cartridge seam has split.

 **NOTE:** Newer versions of LTO tapes have plastic-welded seams to prevent splitting; however, the tapes must be checked for leader pins that may have dropped inside the cassette housing.

**Figure 1-5. Split Seam on LTO Tape**



**Figure 1-6. Media Inspection - Good Tape**



### **Ensure Proper Packaging While Shipping Tapes**

- When you ship a cartridge, ship it in its original or better packaging.
- Always ship or store a cartridge in the vertical orientation and inside the jewel case to prevent damage to the tape edge.
- Use only a recommended shipping container that securely holds the cartridge in its jewel case during transportation.
- Never ship a cartridge in a commercial shipping envelope. Always place it in a box or package.
- If you ship the cartridge in a cardboard box or a box of a sturdy material, ensure the following:
  - Place the cartridge in polyethylene plastic wrap or bags to protect it from dust, moisture, and other contaminants.
  - Pack the cartridge snugly. Do not allow it to move around.
  - Double-box the cartridge (place it inside a box, then place that box inside the shipping box) and add padding between the two boxes.

## Cartridge Storage Conditions

- Before you use a cartridge, let it acclimate to the normal operating environment for 24 hours.
- Ensure that all surfaces of the cartridge are dry before use.
- Do not expose the cartridge to moisture or direct sunlight.
- Always ship or store a cartridge in the vertical orientation and inside a jewel case to prevent damage to the tape edge.
- Do not expose recorded or blank cartridges to stray magnetic fields (for example, terminals, motors, video equipment, X-ray equipment, or fields that exist near high-current cables or power supplies). Such exposure can lead to loss of data or render the blank cartridge unusable.
- Maintain the environmental conditions outlined in the Table 14.

**Table 14. Environmental Specifications for Tapes**

<b>Environmental Factor</b>	<b>Operating</b>	<b>Operational Storage</b>	<b>Archival Storage</b>	<b>Shipping</b>
Temperature	10 °C to 45 °C (50 °F to 113 °F)	16 °C to 32 °C (61 °F to 90 °F)	16 °C to 25 °C (61 °F to 77 °F)	-23 °C to 49 °C (-9 °F to 120 °F)
Relative humidity (non-condensing)	10 % to 80 %	20 % to 80 %	20 % to 50 %	5 % to 80 %
Wet bulb temperature	26 °C (79 °F)	26 °C (79 °F)	26 °C (79 °F)	26 °C (79 °F)

## Cartridge Life

- Durability – 1,000,000 passes on any area of tape, equates to over 20,000 end-to-end passes/260 full tape backups.
- Archival life – 30 years.

## Media Do's and Don'ts

### Do's:

- Store cartridges in their protective cases.
- Handle cartridges with great care.
- Store the cartridge vertically.
- Align cartridges so the grooves interlock.
- Inspect cartridges prior to each use.
- Unload cartridges prior to turning off the drive.
- Allow a 24-hour conditioning period to the operating temperature and humidity before using new or stored cartridges.
- Eject media before turning off the drive.

### Don'ts:

- Touch the media or leader with bare fingers.
- Use pens or pencils during cartridge inspection.
- Drop cartridge.
- Store the cartridge horizontally.
- Disassemble cartridges.
- Ship cartridges in drive.
- Store near magnetic fields (e.g. speakers, monitors, electric motors, power supplies, etc.).
- Use a cartridge that fell from 3 ft or higher.
- Degauss LTO tapes.
- Ship the LTO drive with media loaded.

